



NEW 2021 Products

- Drop-In Frames
- Charisma SEG 3D
- Custom Brackets
- Lollipop Stands
- SEG Trifecta Stand
- Sanitizer Stands
- Banner Stands
- SEG Expo Stand
- Vaccine Privacy Booth
- CounterTops
- Recent Best Sellers
- Cashier Shields
- Incline Stands
- Clear Partitions
- SideBAR

US Made – FAST – No US tariffs
 Custom is our specialty



Testritevisual

www.testrite.com



American made since 1919

May 2021 Edition

Drop-In Frames

Outdoor Folding A Frame & Slim Convex Poster SignHolder

Outdoor Folding A Frames

- Aluminum, legs and stays
- Units collapse & fold compactly
- Accepts graphics from 5/32" up to 1/4" thick
- Top entry slot, non-slip tips
- Steel weight for added stability
- **AF22-OUTDOOR** for 22" x 24" graphic
- **AF24-OUTDOOR** for 24" x 36" graphic

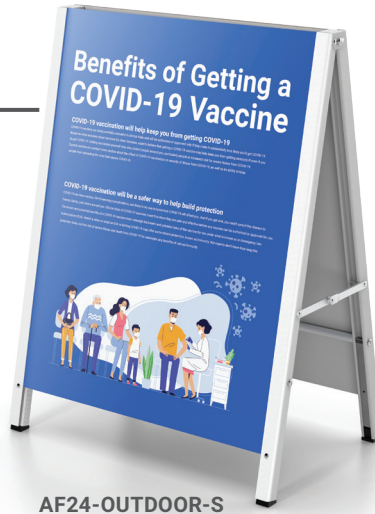

AF24-OUTDOOR-S

Great for Outdoor Use!

↓
For Media
from 5/32"
up to 1/4"
↑

Specify: Model

| Model | Size | Color |
|----------------|-------------|--------|
| AF22-OUTDOOR-S | 22"w x 28"h | Silver |
| AF22-OUTDOOR-B | 22"w x 28"h | Black |
| AF24-OUTDOOR-S | 24"w x 36"h | Silver |
| AF24-OUTDOOR-B | 24"w x 36"h | Black |

-S Satin Silver or -B Matte Black 

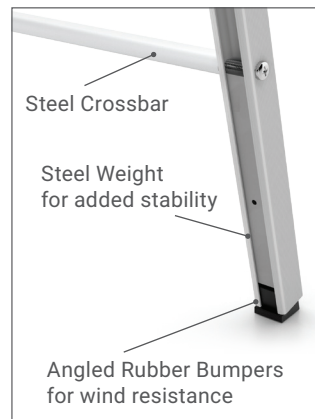

Slim Convex Poster SignHolder

- Rise above customers with key messages
- Perfect for airports, exhibits, retail, restaurants, malls and tradeshows
- Avoid ladders while elevating message
- Change out graphics fast
- Built strong, all metal construction
- Holds 12"w x 92"h graphics



↓
.040" to .060" thick
Styrene Suggested
↑

Benefits of buying US Made

- Quality you can rely on
- Speed - Fast production and shipping
- No tariffs - Safe products
- No customs delays
- Support U.S. jobs



Table top
available

Ideal for
food service



VX1292-S

Drop-In Frames

Blade Poster SignHolder



Blade Poster SignHolders™

- Slender 5/8" thick profile
- Welded steel base
- Suitable for high traffic areas
- Custom sizes and colors available

Amazingly thin!

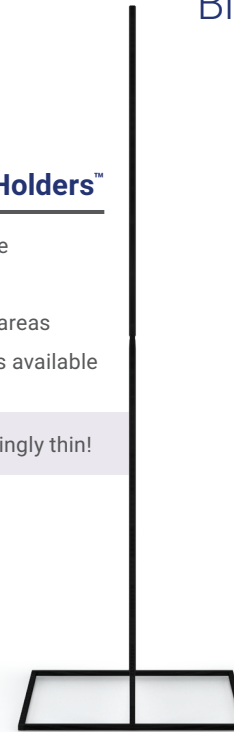

Customization

Sizes, colors, different bases.
Quantity minimums apply.

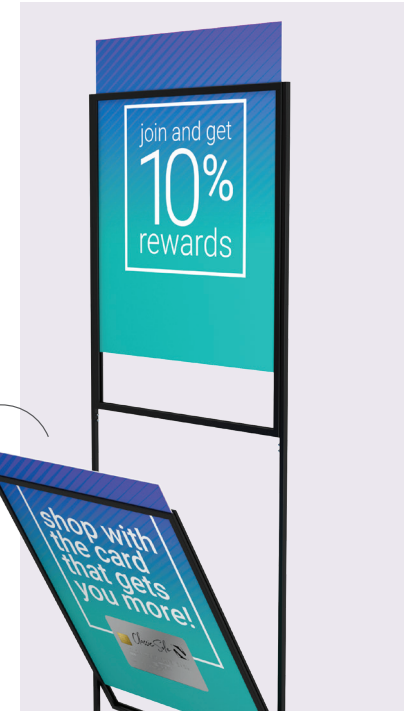

Release snap button and bottom frame pivots for graphic insertion

Specify: Model

| Model | Tiers | Graphic w" x h" | Ht. | Wt. |
|----------|-------|-----------------|-----|---------|
| BL1422-1 | 1 | 14" x 22" | 65" | 7 Lbs. |
| BL1422-2 | 2 | 14" x 22" | 73" | 9 Lbs. |
| BL1422-3 | 3 | 14" x 22" | 88" | 11 Lbs. |
| BL2228-1 | 1 | 22" x 28" | 65" | 8 Lbs. |
| BL2228-2 | 2 | 22" x 28" | 73" | 11 Lbs. |
| BL2228-3 | 3 | 22" x 28" | 93" | 13 Lbs. |

Matte Black 

Accessories



Weighted Cover

BLWC14 For **BL1422** 14" x 22" (~15 lbs.)
BLWC22 For **BL2228** 22" x 28" (~25 lbs.)



SLB3 Lit. Baskets (for 22" w units only)
(1) 11" x 17" tabloids or
(2) 8-1/2" x 11" stacks.



Coroplast® White, 4 mm
COR6 14" x 22"
COR7 22" x 28"



Clear or Matte lenses, sold in pairs.
CPL6 or **CPM6** 14" x 22"
CPL7 or **CPM7** 22" x 28"

Drop-In Frames

Monster Frame Divider



Monster Frame Pedestal SignFrames™

- NST2436-S
- With horizontal divider
- 19" Round 15 lbs base

Monster Frame Shoe Shelf

- Monster Drop-In Frames
- Accommodates graphics up to 1/4" thick
- 1-1/4" profile, top load
- Shown with optional drop in crossbar and custom shoe shelf



Monster Frame Aisle Markers



Monster Frame Divider



Terrific for:

- Wayfinders
- Restaurants
- Retail Environments
- Banks

Frame adapts as your needs change

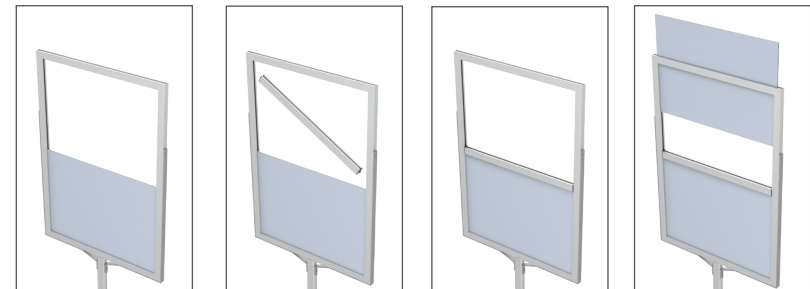

Increased flexibility, subdivide the frame into different graphic spaces. Customized to fit your needs. Use the same frame many different ways.

Drop-In Frames

Floating StandOff Mounts™



Floating StandOff Mount hangs from wall cleat.

Components - Parts

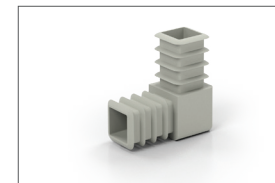

Right angle push in corners.

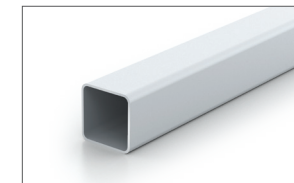

1" square aluminum, quick, tool-free assembly.

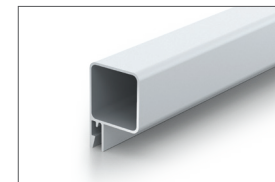

Top section hangs from wall cleat.

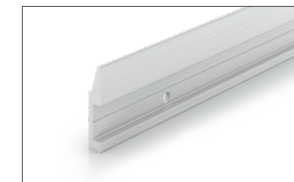

Wall mount cleat includes mounting holes. (mill finish aluminum)

Floating StandOff Mounts™

- Support for the digital image revolution
- Artists everywhere are printing on metal panels, and the images are often eye popping.
- Increase impact by using our new Floating StandOff Mounts – today's new modern way to display digital prints.
- Prints are set off the wall an inch creating a floating effect, framelessly, with no visible hardware.

Bulk Components

| Model | Corners & Tubing |
|------------------|---|
| OATCL4 | 1" Square "L" Corners (Bag of 4) |
| OATCL100 | 1" Square "L" Corners (Bag of 100) |
| OATCSQ72 | 1" Square Aluminum 72" long |
| OATCCR72 | 1" Square Aluminum Cleat Receptive 72" long |
| OATCFC72 | French Cleat 72" long |
| OATCHB100 | High Bond Tape, Pack of 100 pcs. 3" long |

Complete Kits

Includes StandOff Mount, Aluminum Mounting Cleat & High Bond Mounting Tape.

| Model | StandOff Mount | Graphic Size |
|----------------|----------------|---------------------------------|
| OAT1818 | 18"w x 18"h | 24"w x 24"h Graphic recessed 3" |
| OAT1830 | 18"w x 30"h | 24"w x 36"h Graphic recessed 3" |
| OAT2434 | 24"w x 34"h | 30"w x 40"h Graphic recessed 3" |
| OAT3042 | 30"w x 42"h | 36"w x 48"h Graphic recessed 3" |
| OAT4266 | 42"w x 66"h | 48"w x 72"h Graphic recessed 3" |



Specify Orientation

- H Horizontal (Landscape)
- V Vertical (Portrait)

Digital print (not included), attached to StandOff Mount.

Drop-In Frames

Lollipop Stands™

Lollipop Stands™

- Unique drop-in design
- 13" and 15" diameter standard models
- Use with circular or shape cut rigid graphics
- Lightweight & portable
- Built to last with all metal construction
- 13" diameter 7 lbs steel base
- Ideal for double sided graphics
- Unassembled for cost efficient shipping

↓
For Rigid Media
up to 6mm / 0.236"
↑

| Model | Minimum Graphic Size | Wt. lbs |
|--------------|--------------------------|---------|
| LOLPOP13-H-B | 13" Diameter half circle | 9 |
| LOLPOP15-H-B | 15" Diameter half circle | 9 |

Color -B Matte Black 



LOLPOP15-H-B

Ideal for circles
+
Limitless Shape Cut Options



2x screws for strong attachment

LOLPOP13-H-B



Drop-In Frames

Lollipop Stands™

Perfect for Restaurants, Retail, Hotels, and more!



Custom is our specialty

We can customize a solution to your needs, including size, shape, color, and more!
Min qty 25+ depending on complexity



Wall or column mounts available



Banner Stands

Allé Fabric Pillowcase Stand



Curved Allé Stand

APC1 with
GFX-APC



Curved Angled Stand

APA1 with
GFX-APA



Curved Flat Stand

APF1 with
GFX-APF



Unique Eye Catching Shapes

| Stand | Graphic | Description |
|-------|---------|-------------|
| APC1 | GFX-APC | Curved Allé |
| APA1 | GFX-APA | Angled Allé |
| APF1 | GFX-APF | Flat Allé |

Beautiful graphics & attractive shapes demand attention!



| Model | Travel Bag Description |
|-------|---|
| EBG-A | Travel Bag to hold the stand and graphic. |

Allé Pillowcase Banner Stands™ Graphics

- Customized versions available and quoted on request.
- Close tolerance aluminum alloy tubing.
- Swaged and spring button construction.
- Weighted steel base with reliable support bushing.
- Units ship economically and are easy to assemble without tools.
- Designed for ~33" w x ~80" h graphics



Units ship economically and are easy to assemble without tools.

Banner Stands

American Eagle Pole Pocket

American Eagle Banner Stand

Elegant - Fixed Width Banner Stands

- Lightweight & strong
- Pole pocket mounting
- Satin finishes
- Portable, built to last
- Steel weighted bases
- 8' & 10' sides in 2 screw together sections
- Aluminum alloy

| Stand | Graphic | Graphic Size | Bag |
|---------|-------------|---------------|--------------|
| FBS56 | GFX-FBS56 | 5' w x 6' h | - |
| FBS58 | GFX-FBS58 | 5' w x 8' h | EBG9 |
| FBS66 | GFX-FBS66 | 6' w x 6' h | - |
| FBS68 | GFX-FBS68 | 6' w x 8' h | - |
| FBS86 | GFX-FBS86 | 8' w x 6' h | - |
| FBS88 | GFX-FBS88 | 8' w x 8' h | EBP4 or EBG9 |
| FBS108 | GFX-FBS108 | 10' w x 8' h | EBG9 |
| FBS1010 | GFX-FBS1010 | 10' w x 10' h | EBG9 |

2-3/4" Pole Pocket recommended for graphics

| Model | Travel Bag Description |
|-------|-------------------------------------|
| EBG9 | 63" Single Carry Bag |
| EBP4 | Premium Padded Bag - 3" x 12" x 48" |

Pole Pocket mounting for 1-1/4" diameter crossbars



Satin finished aluminum tightening pucks



8' & 10' wide units have center support plate.

Please note: Support plate is off center.

Aluminum alloy 1-1/4" satin finished uprights

Quality constructed, built to last

Racetrack oval laser cut bases

Center Support to level crossbar

FBS86

Color



-S Satin Silver

Unit ships knocked down for cost efficient transit.

LED with Clamp for Graphic Stands



LEDLF



CounterTop Displays

Double LL Mounts & Adjustable Double LL Mounts

CounterTop Double LL Mounts™

- Heavy gauge solid steel
- Welded construction
- Texture powder coated finish
- 2-1/2" Wide x 1" High
- Non skid, non marking pads
- Rounded corners
- Polybagged, bulk packed

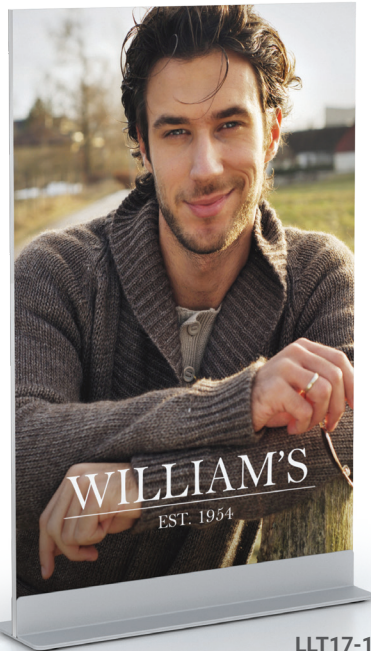

LLT17-14-S

Redesigned!

Comes fully assembled, no tools required

Sleek modern design

Graphic simply drops into receiving track

3/16" Graphic Track

| Model | Track Length |
|-----------|--------------|
| LLT85-316 | 8-1/2" |
| LLT11-316 | 11" |
| LLT14-316 | 14" |
| LLT17-316 | 17" |
| LLT24-316 | 24" |
| LLT30-316 | 30" |

1/4" Graphic Track

| Model | Track Length |
|----------|--------------|
| LLT85-14 | 8-1/2" |
| LLT11-14 | 11" |
| LLT14-14 | 14" |
| LLT17-14 | 17" |
| LLT24-14 | 24" |
| LLT30-14 | 30" |

Specify: Size — Color -S Satin Silver or -B Matte Black  

Adjustable CounterTop Double LL Mounts

- Accepts all self standing media up to 1/2" thick
- Steel construction
- 2-1/2" Wide x 1" High
- Powder coated finishes
- Tremendous flexibility

Adjustable screws to accommodate up to 1/2" thick media

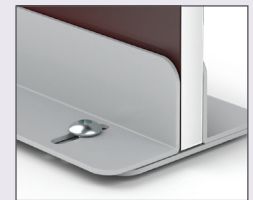
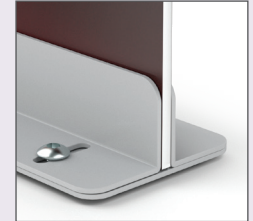

Model Length

| | |
|--------|--------|
| ALLT85 | 8-1/2" |
| ALLT11 | 11" |
| ALLT14 | 14" |
| ALLT17 | 17" |
| ALLT24 | 24" |
| ALLT30 | 30" |

Customization ideas

- Choices include custom
- Lengths
- Color matches
- Graphic thickness
- Multiple track units for layering effects



CounterTop Displays

Wireform

Wireform Fabric Pillowcase Stands



- Use dye sublimated fabric graphics on these economical stands.
- Simple slip over and on, Double sided impact.
- All metal, welded, matte black, fully assembled.

| Model | Graphic Size |
|----------|---------------|
| WFPC1117 | 11" w x 17" h |
| WFPC1422 | 14" w x 22" h |



All CounterTop Stands are bulk packed.

Customize for your needs!

Custom requests whether for size, color or other aspect are encouraged.



Wireform Flip Ring Stands

- Use semi-rigid graphics with holes on these economical stands.
- Use a single graphic or multiple ones and "flip" from one hanging graphic to another.
- All metal, welded, matte black, 1" silver rings, fully assembled.

| Model | Graphic Size | Rings |
|----------|-------------------|-------|
| WFFR57 | 5" w x 7" h | 2 |
| WFFR8511 | 8 -1/2" w x 11" h | 2 |
| WFFR1185 | 11" w x 8-1/2" h | 3 |
| WFFR114 | 11" w x 4" h | 3 |

Wireform J Hook Stands



- Use semi-rigid graphics with holes on these economical stands.
- Simply hang punched graphics from hooks. Double sided impact.
- All metal, welded, matte black, fully assembled.

| Model | Graphic Size | J hook centers |
|----------|---------------|----------------|
| WFJH1117 | 11" w x 17" h | 5 1/2" |
| WFJH2217 | 22" w x 17" h | 11" |
| WFJH3614 | 36" w x 14" h | 18" |



Charisma SEG™

Incline Stands



INCSEG1-2260-S

Incline Stands™

- All metal construction, built to exacting standards
- Ships flat, 60 second set up, portable
- Many different frame options, single or double sided
- Lightweight and strong, but portable and effective
- Standard graphic size is 22" x 60"

A nice way to provide ambience and information in retail settings.

Our most popular Front Options:

EasyOpen SnapFrame™
Poster & paper signs up to 1/32"

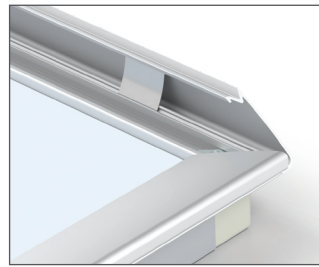

Monster Drop-In Frames™
Thin graphics up to 1/4" board

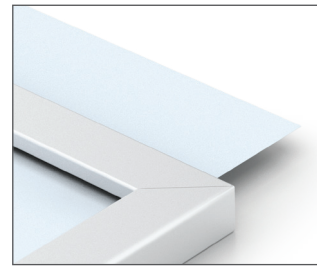

Charisma SEG Frame™
Silicone edge fabric graphics

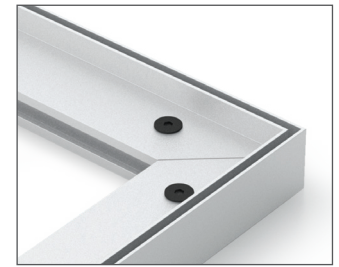

Standard and custom models available



INCE01-2260-S
One-sided
SnapFrame



INCE02-2260-B
Two-sided
SnapFrame



INCNST1-2260-B
One-sided
Monster Frame



INCNST2-2260-S
Two-sided
Monster Frame



INCSEG1-2260-S
One-sided
SEG Frame



INCSEG2-2260-B
Two-sided
SEG Frame

Charisma 3D SEG™

Triangular Towers

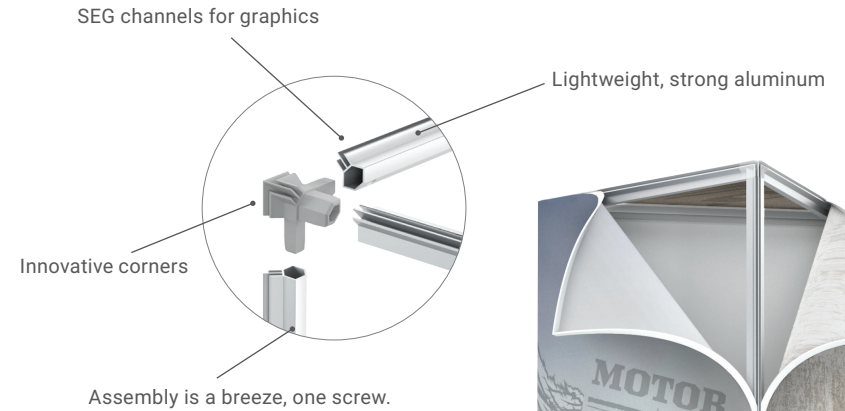
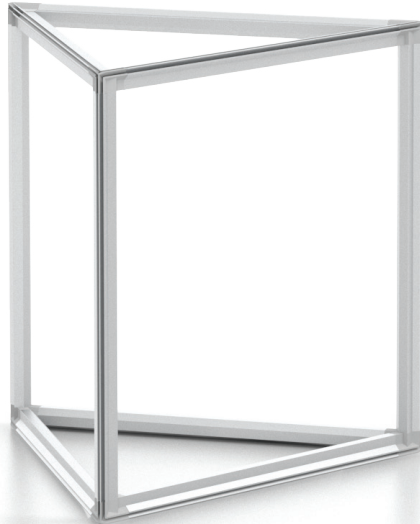

Triangular Towers – Non Lit

- Floor model standard
- Unique profile and corner
- Easy SEG graphic changeouts
- Square or Triangle Shape
- Satin Silver Finish
- Custom sizes available
- Ships flat for cost effective shipping
- Hanging quoted on request

Easy to attach
and change out graphics

Available Torpedo LED Exhibit Light

- Plug and play
- ETL Listed
- 6500K color temp.
- 6' high units have two lights

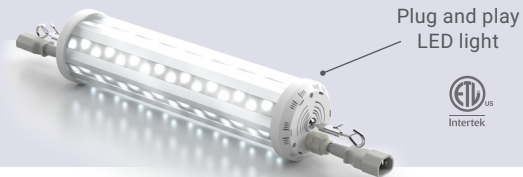

Custom Sizes
Available

XS3G

Square Cubes

| Model | Lit | W x D x H |
|-------|----------|--------------|
| XS2C | XS2C-LED | 2' x 2' x 2' |
| XS3C | XS3C-LED | 3' x 3' x 3' |
| XS4C | XS4C-LED | 4' x 4' x 4' |

Rectangular Towers

| Model | Lit | W x D x H |
|-------|----------|--------------|
| XS2T | XS2T-LED | 2' x 2' x 6' |
| XS3T | XS3T-LED | 3' x 3' x 6' |
| XS4T | XS4T-LED | 4' x 4' x 6' |

Triangular Towers

| Model | Lit | W x D x H |
|-------|----------|--------------|
| XS2G | XS2G-LED | 2' x 2' x 6' |
| XS3G | XS3G-LED | 3' x 3' x 6' |
| XS4G | XS4G-LED | 4' x 4' x 6' |

Charisma SEG/LED Inside Out Light Boxes™

Recent Best Sellers

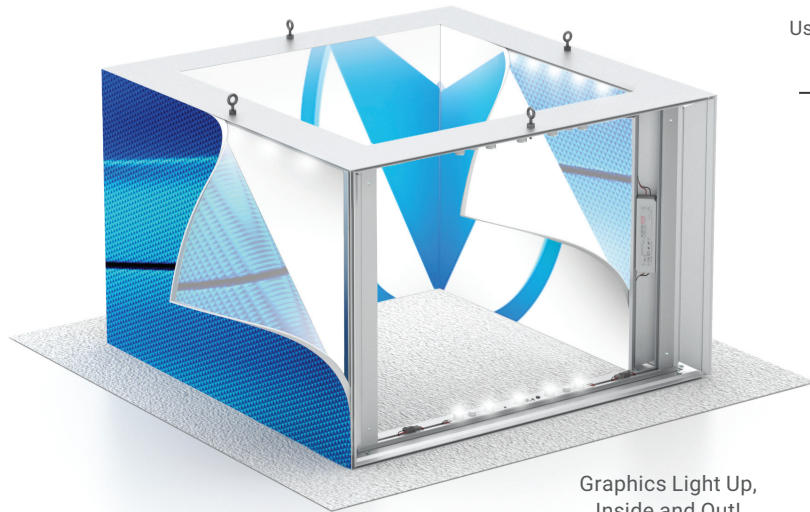

Graphics Light Up,
Inside and Out!

Usable in different configurations
L's, U's and Straight Walls

 **CERTIFIED**
the standard in safety

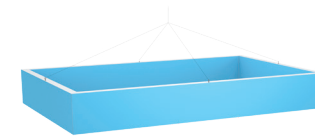

As an Overhead

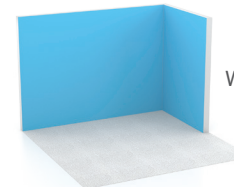

Wall Corners

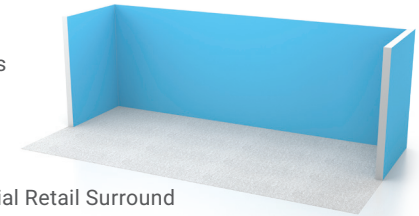

Experiential Retail Surround

Illuminated Inside and Out!

- LED light strips along top and bottom rails
- LEDs feature wide beam angles, and long life
- Lights are 6500°K color temp, low heat
- Aluminum trim is satin silver
- Easy SEG graphics installation and change out
- Power supply cords exit the top of the lightbox

SEG/LED Inside Out Light Boxes™

- Dramatic effects
- Lighting – both inside and out
- Heavy duty construction
- Easy SEG installation
- Custom sizes available
- Satin silver finish

| Model | W x D x H |
|-----------------|--------------------|
| XSI084 | 8' x 4' x 2-1/2' |
| XSI0812 | 8' x 12' x 2-1/2' |
| XSI01010 | 10' x 10' x 2-1/2' |

Allow additional lead time
for these units

Great For:

- Retail stores
- Showrooms
- Lobbies
- Exhibitors

Suggested Use:

- Hanging
- Corners
- Freestanding
- Partitions



Charisma SEG Trifecta and Expo Stand™

Recent Best Sellers

Ultimate Flexibility
Use with 1, 2 or 3 graphics!



XP3N1
with (3)
graphics

| Model | Height | Weight |
|-------|--------|--------|
| XP3N1 | 72" | 30 lbs |

Charisma Trifecta Stands™

- Double Sided Charisma SEG
- Show One, Two or Three Graphics Per Side
- Aluminum alloy frame
- Weighted 22" x 18" steel base

Display Options For Each Side

- (1) 22" x 72" graphic
- (3) 22" x 24" graphics
- (1) 22" x 24" and (1) 22" x 48" graphics

Charisma SEG Double Sided Expo Stands

- Easy SEG Insertion
- Aluminum construction
- Double sided viewing
- Simple assembly
- Bases: Full width (XPS) / Round base (XPLF)

Lit LED units
also available



XPS72



XPS28

| Model | Graphics | Graphics Size | Base | Uprights | Ht. | Wt. lbs |
|--------|----------|---------------|------------|----------|-----|---------|
| XPS28 | 2 | 22" x 28" | 24" x 12" | 2 | 64" | 21 |
| XPS36 | 2 | 24" x 36" | 24" x 12" | 2 | 72" | 22 |
| XPS72 | 2 | 24" x 72" | 24" x 12" | N/A | 72" | 22 |
| XPLF28 | 2 | 22" x 28" | 17" Round | 1 | 64" | 19 |
| XPLF36 | 2 | 24" x 36" | 17" Round" | 1 | 72" | 20 |

Recent Best Sellers

Hercules Roll Around SignHolders™

- Heavy duty 22" x 28" Portable SignHolders
- 30 pound steel powder coated base
- 3" ball bearing locking casters with brakes
- Double sided viewing
- Aluminum alloy frames
- Large format oval uprights



For Media
up to 3/16"

Top load 3/8" margin
covered by frame.

RL328-S



Perflex Pedestal SignFrame™

- Heavy duty extruded alloy
- Accepts graphics to 3/16" thick
- Curvilinear frames, top slot
- All frames are open 2 sides
- All Metal - Contemporary Design

For Media
up to 3/16"

IMPRINTABLE

SF3S-SQ-X-V-S

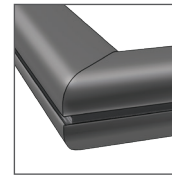
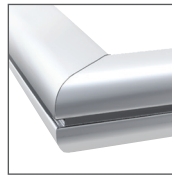

Sleek, functional, curvilinear design,
available in Satin Silver or Matte Black

Top Loading, Accepts
Media To 3/16" Thick

Optional
Round Base

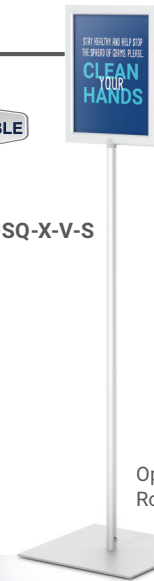

Custom sizes Available

Harmony Air Banner Stands™

- Portable - fits in airline carry on
- 1" constant diameter aluminum uprights. Sleek design.
- Swaged, spring button, and shock cord construction.
- Curved or square tops
- Feather light at 3-4 lbs
- Tubular aluminum base

HMN1-A-S

Rolling carry-on
bag available
EBG-S

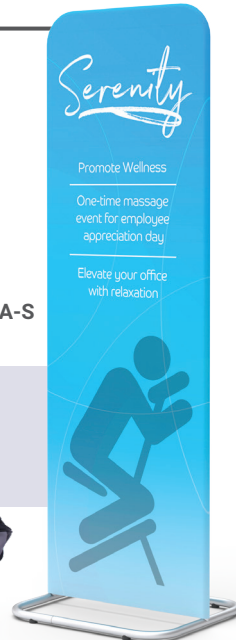

Fabric Hemmed Graphics

Plastic dowels (included) insert into
hemmed pole pockets top and bottom.

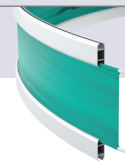

or

Styrene Graphics

Hang from internal plastic
screw spacer sets (included).

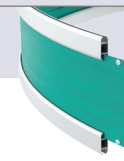

Halo Rail™ Kits

- Curved satin aluminum profiles
handsomely house pole pocket graphics
- Strong, yet lightweight
- Height is 2-1/2" higher than graphic
- Ships ready for very easy assembly.
Eyebolts come already attached
- Quick graphic changeouts
- No costly vertical struts needed



Clear Room Partitions™

Recent Best Sellers



The Clear Room Safety Partition is ideal for the office, restaurant, salon, hotel lobby and any other environments that require social gathering. The movable safety partition allows you to setup spaces on demand.

Clear Room Partitions™

- Offered in 2 style bases - Heavy Steel bases & Wheeled bases
- Fire retardant clear plastic lens (NFPA701)
- Portable, strong & lightweight
- Quick and easy setup
- Knocked down for shipping savings
- Offered in 2 sizes, custom sizes available



Customize
for your needs!



CLRPART-3672-WHL

Lower Cost Freight
with rollable vinyl!



CLRPART-7272

Color



-S Satin Silver

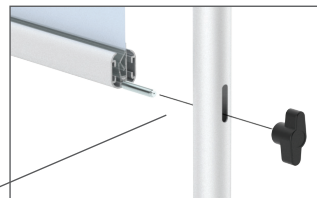

Heavy Steel Base



Wheel Base

| Model | Size | Description |
|------------------|---------------|---|
| CLRPART-3672 | 36" w x 72" h | Floor Partition Stand with clear vinyl |
| CLRPART-7272 | 72" w x 72" h | Floor Partition Stand with clear Vinyl |
| CLRPART-3672-WHL | 36" w x 72" h | Floor Partition Stand with wheel base and clear vinyl |
| CLRPART-7272-WHL | 72" w x 72" h | Floor Partition Stand with wheel base and clear vinyl |

Custom Brackets

Retail Customer Examples

Shelf Attachment

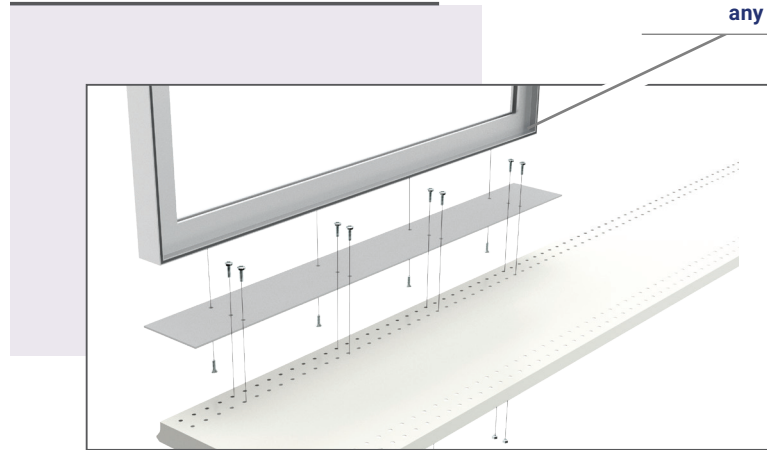

Attach our Graphic Frames to existing Gondola Shelving.



Connect any frame

Slotted Standard Brackets

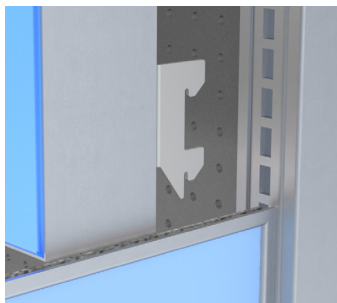

Brackets to fit any standards including Lozier, Madix, or Opto, and warehouse racking

Standoff from 1/2" Merchandising Bar



Standoff
Sturdy, welded construction

Drop into Uprights

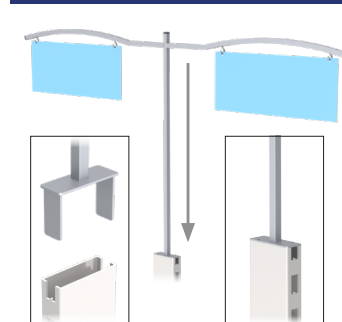

Base
Slides into existing Lozier, Madix, or warehouse racking

Drop into Existing Cup Brackets

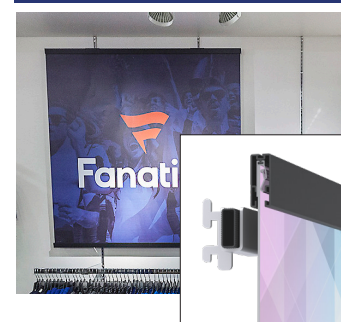

Drop into existing cup brackets, aluminum SnapGraphics SN5

U Brackets

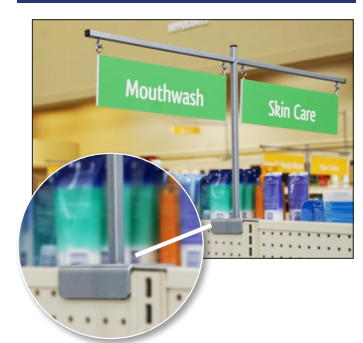

Brackets
Fits over existing fixture

Tailored to your application!



Custom is our specialty – Reach out today

Hinged Shelf Covers



Soft close
Stay open hinge covers shelves with or without merchandise

Pegboard / Slatwall Standoffs



Clamp Under Case

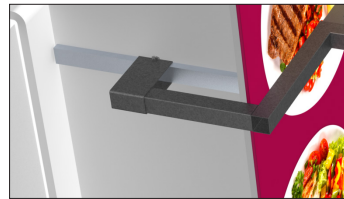

Underside View
"U" bracket is fastened to existing beam under display case



Clamp Bases



Swivel parallel or perpendicular

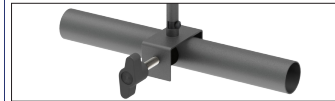

Shelf Divider Graphics



Back View

Angled Header Standoff Frame

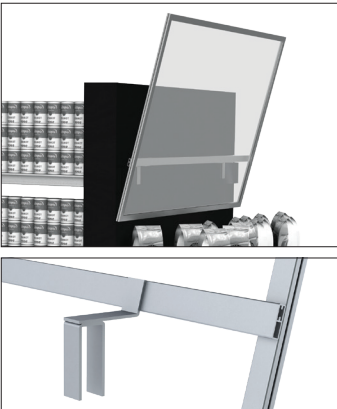

Merchandising Arm Signs



Fixture Cover



Mounting Brackets hangs onto (4) posts

Fixture Spine Shoe Divider



Fits over existing fixture spine

Example of recent fabricated parts and projects

Hand Sanitizer Dispenser Stands

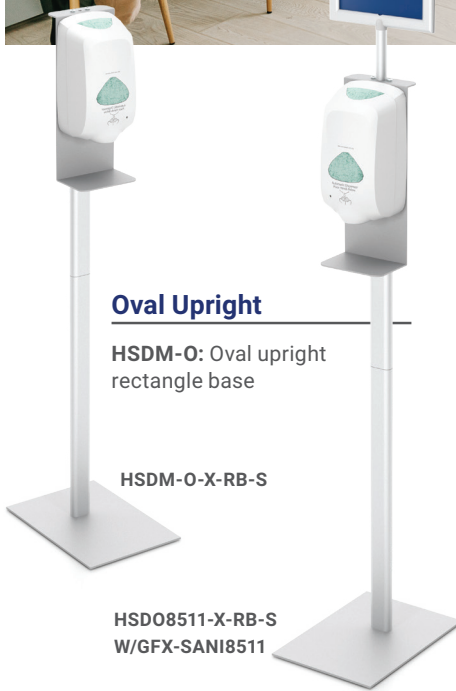

Oval Upright

HSDM-O: Oval upright rectangle base

HSDM-O-X-RB-S

HSD08511-X-RB-S
W/GFX-SANI8511

Hand Sanitizer Dispenser Stand

- Fixed 48" H upright (2 section upright)
- Unit without sign includes a screws at top for attaching sign back plate
- Optional SignHolder - Attaches to top of back plate, top loading sign frame 8.5" W x 11" H or 11" W x 14" H
- Optional styrene graphic (GFX-SANI8511 and GFX-SANI1114)
- Custom sizes available starting at qty 25, reach out for a quote



Manual – Lowest Cost Stands

HST: Floor stands for smaller bottles



HST-X-SQ-S

HSG: Floor stands for gallon bottles



HSG-X-S

HSTW: Wall Mount bottle holder (set of 4)



HSTW-S

Automatic Dispenser Stands

HSDM: Floor stands for automatic dispensers



HSDM-X-SQ-S

HSD8511 or HSD1114: Floor stands with frame



HSD1114-X-SQ-S

HSC: Countertop dispenser holder



HSDC-S

Foot Operated

HSG: Foot operated sanitizer dispenser



HSG-FOOT-S

Wipes

HSW: Floor stands for wipes



HSW-X-SQ-S

HSW114-X-SQ-S

HSW-W: Wall Mount wipes holder



HSW-W-S

Dispensers, Sanitizers, & Wipes not included

Vaccine Privacy Booth

Fabric graphics create
branded privacy booths



PW353 w/GFX-PW353-D | Stand with double sided pillowcase graphic

Vaccine Privacy Booth

- Brandable
- Portable
- Optional Fabric Graphics



Rigid Panel Vaccine Privacy Booth

- Rigid Panels and
Skyscraper Mounts



(1) SKMM6-S | (2) SKRA6-S | (1) SKCU6-S
and Rigid Graphics (not included)

Cashier Shields™

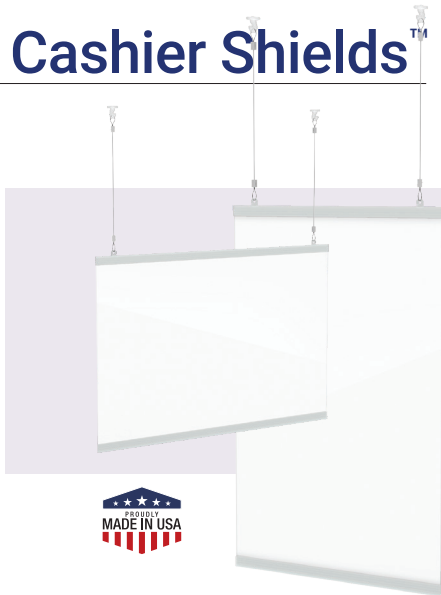

Hanging Cashier Shield Kit - Includes:

- Top and bottom GC Gripper Extrusions
- 1 Thin clear lens included
- 2 Universal hanging clips
- 2 Cables with adjustable cable locks
- Clear hinged hooks for dropceiling attachments
- Standard 28" w x 22" h or 56" w x 22" h

| Model | Size | Description |
|-----------|---------------|----------------------------|
| GCHS-2822 | 28" w x 22" h | 2 ANC05, 2 ADC1312, 1 Lens |
| GCHS-5622 | 56" w x 22" h | 2 ANC05, 2 ADC1312, 1 Lens |



C-clamp install

Fixed Position System

Custom Example – Minimum Qty of 50 –
Designed to your specification!

Each Kit Includes:

- Mini Oval Uprights with panel mounting hardware
- Put holes in your clear plastic to mount
- Non-marring clamp on base
- Custom sizes available

Adjustable Channel Free Standing and "L" Shape System

Custom Example – Minimum Qty of 50 – Designed to your specification!

- Extremely Flexible System
- Quick connecting cross bars allow height of panels and size of access openings to be easily adjusted.
- Sturdy construction – free standing or on wheels
- Configurable into multiple sections or into "L" Shape to create additional protection for Cashiers & Customers
- Roll Around protective shields
- Make single or multiple sections

Adjustable Channel System

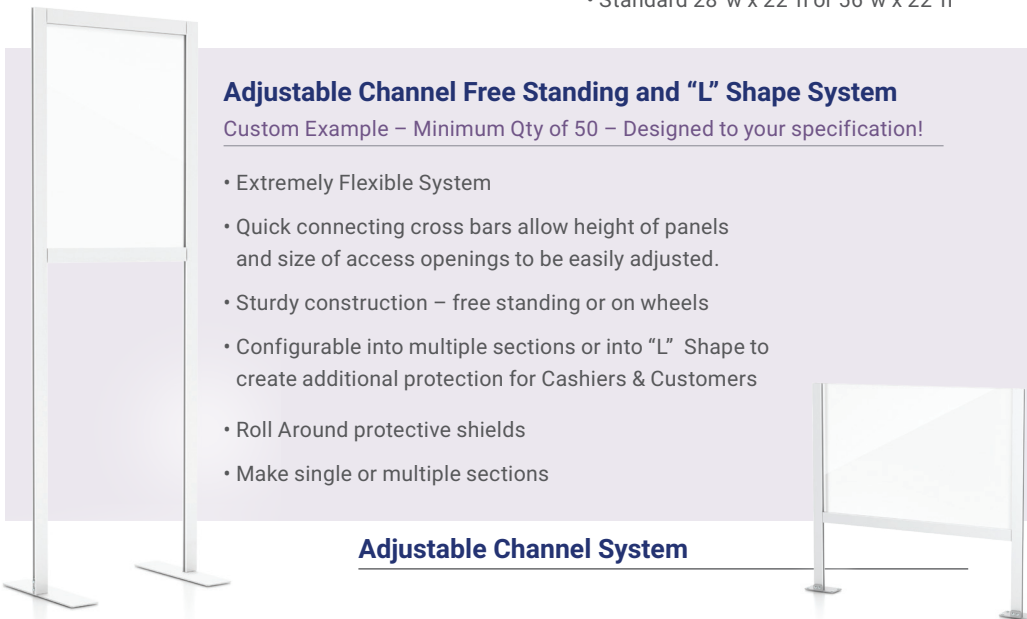

Free Standing Shield - Fixed Width

- 1/2" ID channel aluminum uprights
- Skyscraper Mounts™ | No minimums
- One piece heavy duty steel base
- Use .060 up to 1/2" thick plastic or acrylic
- Steel set screws lock panels in place (plastic set screws available if needed)
- Custom stop position is available by request

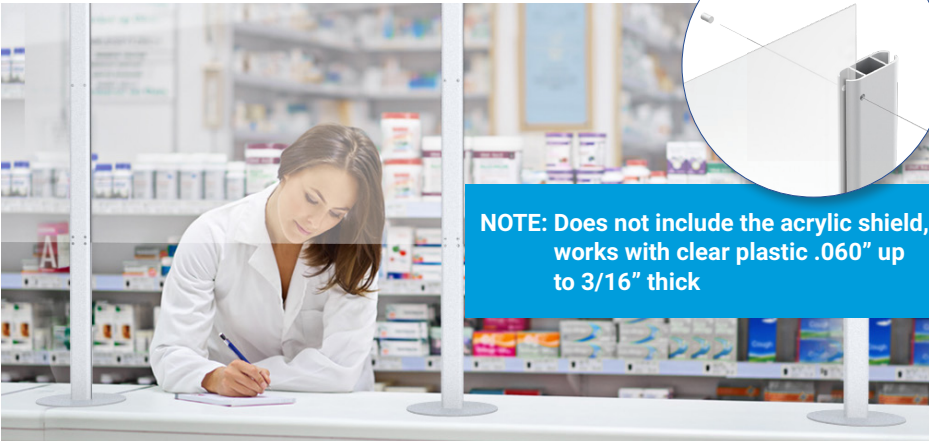

NOTE: Does not include the acrylic shield, works with clear plastic .060" up to 3/16" thick

Cashier Shields

- Aluminum uprights with steel bases
- Non-marring base options
- Use your own acrylic .060" up to 3/16" thick
- Standard uprights height is 36"

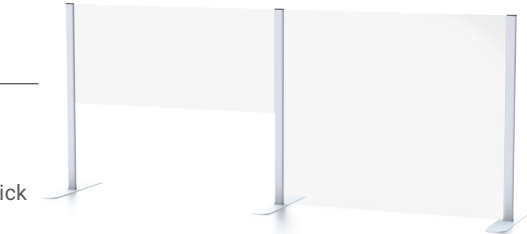

• CBSHR-SS-RT-S (Pair of end uprights) • CBSHR-DS-RT-S (Center upright sold individually)

Base Options

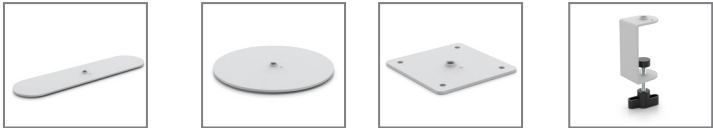

Racetrack Base (-RT) with non-skid Round Base (-RD) with VHB tape Square Drill Down Base (-DD) Clamp On Base (-CL)

Custom Bases Available

| End Uprights w/Bases sold as a pair | Description | Center Upright w/Base sold individually |
|-------------------------------------|--|---|
| CBSHR-SS-RT-S | 36" h Uprights w/Racetrack Oval Bases | CBSHR-DS-RT-S |
| CBSHR-SS-RD-S | 36" h Uprights w/Round Bases | CBSHR-DS-RD-S |
| CBSHR-SS-DD-S | 36" h Uprights w/Square Drill Down Bases | CBSHR-DS-DD-S |
| CBSHR-SS-CL-S | 36" h Uprights w/Clamp on Bases | CBSHR-DS-CL-S |



Economical Cashier Shields

- Aluminum uprights with steel bases
- Non-marring base options
- Use your own acrylic or plastic lens .020" up to 3/16" thick



Base Options



| Model | Description |
|-------------|--|
| PVT1 | Tabletop Exhibit, 4 Uprights 24", Holds 3 Panels, 12 Clips |
| PVT2 | Tabletop Exhibit, 5 Uprights 24", Holds 4 Panels, 16 Clips |
| PVT3 | Tabletop Exhibit, 4 Uprights 36", Holds 3 Panels, 12 Clips |
| PVT4 | Tabletop Exhibit, 5 Uprights 36", Holds 4 Panels, 16 Clips |

SideBAR Table™

Brandable drink table perfect for upselling consumers.
Elevate indoor and outdoor dining.



Rigid printed collateral or menu



Surface perfect for brand building



Digital Print Opportunities

Table Branding:

- Brand the table - ideal for brand sponsorship
- Raise awareness in retail setting when product is offered

Menu / Printed Collateral

- Drop in menu to enable upselling, provide recurring print revenue stream

Ships FAST

- US Made – Manufacturer direct pricing
- All metal construction



Testritevisual

www.testrite.com



American made since 1919

May 2021 Edition